DanuP-2-Gas

Power-to-gas čvorište: Staze i procesi pretvorbe mase/energije, optimalno dimenzioniranje i raspoređivanje rada



Nacionalna DanuP2Gas radionica za Hrvatsku, Zagreb, 24.11.2022.



Sveučilište u Zagrebu Fakultet elektrotehnike i računarstva, Laboratorij za sustave obnovljivih izvora energije



Prof. dr. sc. Mario Vašak, voditelj Laboratorija



Power-to-gas (P2G) čvorište

- Skup procesa za pretvorbu i pohranu mase/energije kojima se integrira sljedeće energetske vektore i materijale
 - Električna energija, Prirodni plin, Toplina, Voda
 - Biomasa, Biougljen
 - Bioplin, Sintetički plin, Biometan, Vodik, Kisik, Ugljični dioksid
- Vođen na fleksibilan način kako bi se iskoristile prilike koje postoje na tržištima energije/materijala/fleksibilnosti te ujedno „energizirao” ugljik iz otpadnih organskih tvari



P2G čvorište

- Može se planirati kao GreenField (GF) investicija ili kao kolocirano s postojećim postrojenjem obnovljivog izvora energije (Renewable Energy Plant, REP) i/ili s postojećim industrijskim postrojenjem (Industrial Plant, IP)

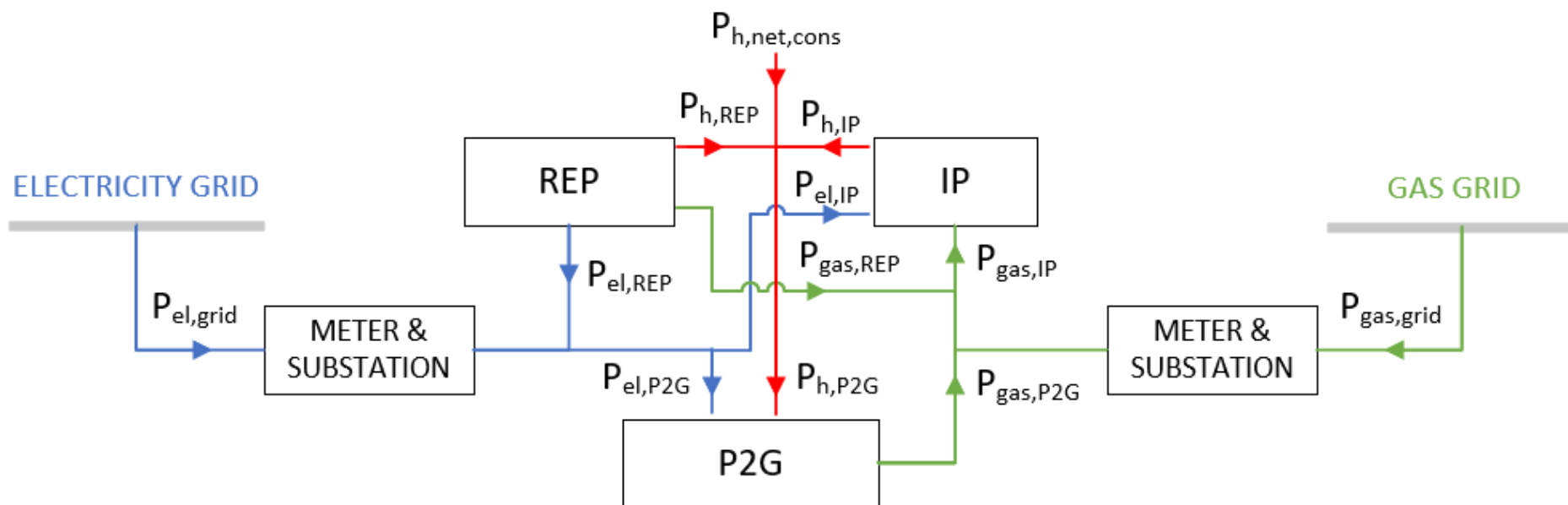

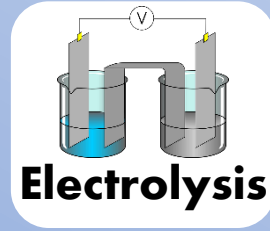

P2G čvorište –
jednostavno

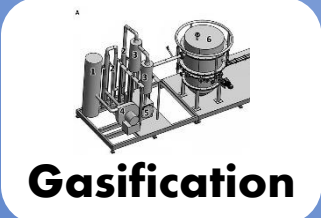
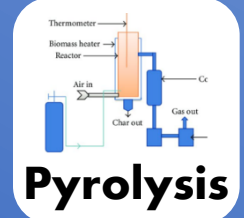
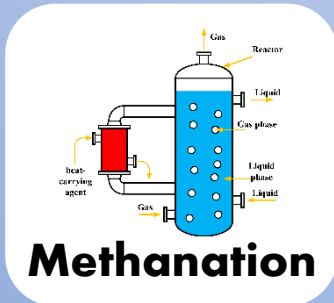
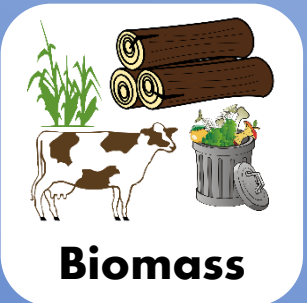

P2G čvorište – potpuno

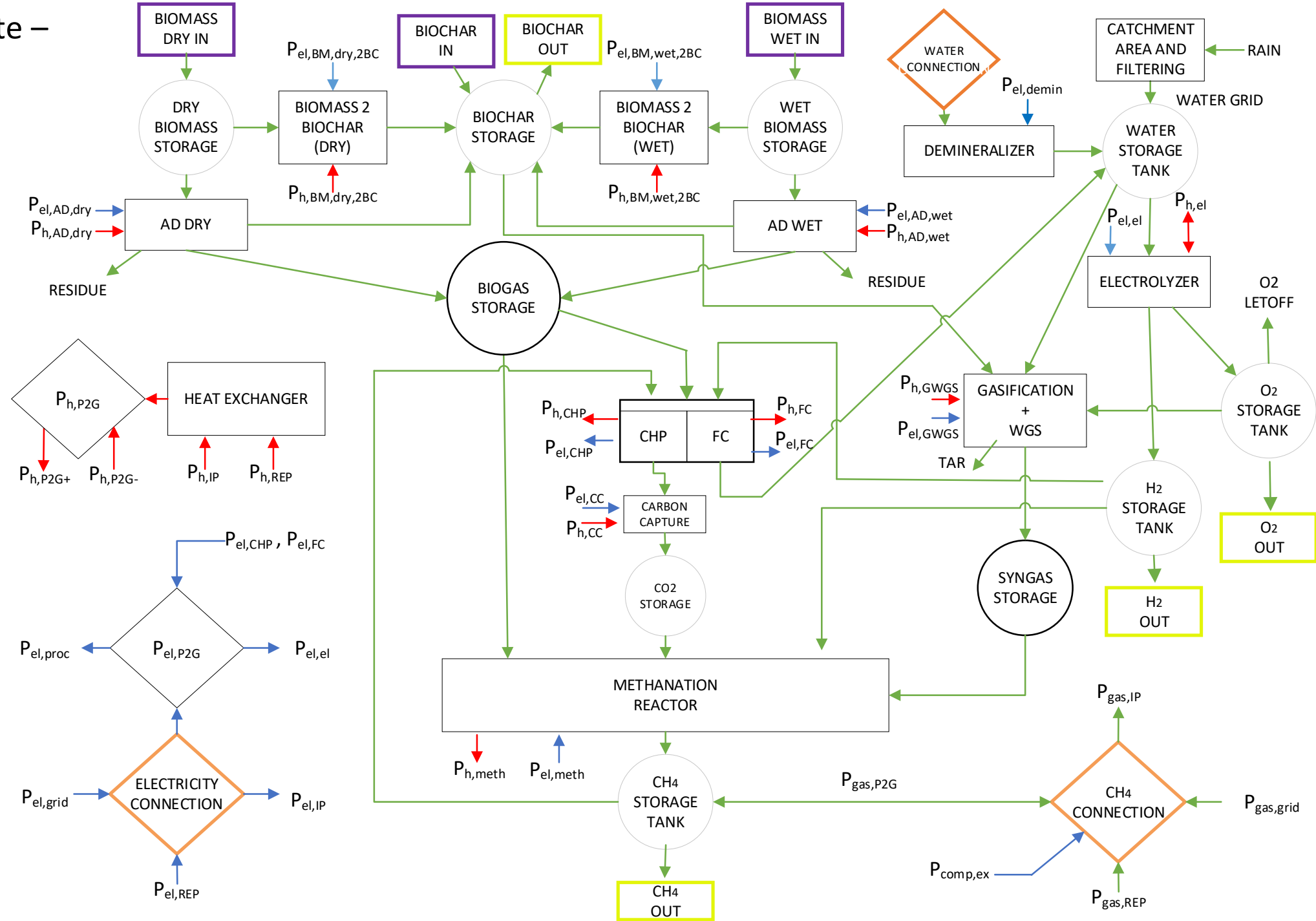



Alati na Danube Energy Platform

- **Dunavska energetska platforma (Danube Energy Platform)** razvijena je u sklopu projekta DanuP2Gas
- Alati dostupni u okviru Platforme olakšavaju planiranje investicija i daljnje istraživanje i razvoj vezane uz P2G čvorišta, posebice za dunavsku regiju (Danube Region, DR)
- **Studije predizvodljivosti (Pre-feasibility studies)** – Skup studija predizvodljivosti za P2G čvorišta u 10 DR zemalja (10DRC: DE, SI, AT, CZ, SK, BG, RO, HU, HR & RS)
- **Katalog poticaja (Subsidy Catalogue)** – Pretraživ skup financijskih instrumenata za investicije i istraživanje P2G čvorišta u 10DRC i transnacionalno
- **Transnacionalna strategija (Transnational Strategy)** – Strategija za povezivanje sektora električne energije i plina u 10DRC
- **Baza podataka za biomasu i infrastrukturu (Biomass & Infrastructure Database)** – Podatci o biomasi i infrastrukturi koje su relevantne za P2G čvorišta u 10DRC
- **Atlas obnovljive energije (Renewable Energy Atlas)** – GIS alat s podacima i grafičkim rasporedom važnih elemenata za P2G čvorišta u 10DRC
- **Optimizacijski alat (Optimization Tool)** – Alat za određivanje optimalne veličine pojedinih komponenata P2G čvorišta te njihova optimalnog rasporeda rada

<https://danup2gas.eu>



Koncept rada s Atlasom i Optimizacijskim alatom

Atlas obnovljive energije:

- Odabir izvora biomase
- Odabir P2G lokacije na karti / Kolokacija s postojećim REP/IP
- Izračun prijevoznih ruta

Preuzimanje odabira elemenata

.json dokument

Optimizacijski alat – Excel korisničko sučelje:

- Učitavanje .json dokumenta stvorenog u Atlasu u Excel
- Dodavanje/mijenjanje ulaznih podataka za optimizaciju u Excelu
- Pokretanje optimiranja
- Pregled rezultata dobivenih optimiranjem: veličine komponenata P2G čvorišta i raspored njihova rada

Pokretanje optimiranja

Optimizacijski alat –
Optimizacijski pozadinski
program temeljen na
Pythonu

Predaja rezultata



Ulazi u Optimizacijski alat (Excel sučelje)

- **Lokacija P2G čvorišta** (samo u Atlasu, nije potrebno kod ručnog unosa u Excel), **moгуća kolokacija s REP/IP te njihovi parametri** (.json ili Excel unos)
- Dopušten **period povrata investicije, njen najveći iznos, razina potpora** (Excel unos)
- **Vremenski period za raspoređivanje rada i vremenska diskretizacija za električnu energiju** (Excel unos)
- **Količina oborine po mjesecima** (predefinirano 0 u Excelu, moguća promjena)
- **Cijene električne energije, plina topline i vode, te mrežarine pri investiciji i u radu** (.json ili Excel unos)
- **Izvori biomase** koje se razmatra za P2G čvorište: godišnja količina, cijena, vlažnost, cijena transporta i udaljenost (.json ili Excel unos)
- **Izvori biougljena** koji se razmatraju za P2G čvorište: godišnja količina, cijena, specifikacije troškova prijevoza i udaljenosti (.json ili Excel unos)
- **Lokalni tržišni uvjeti** za punjenje u boce **vodika, kisika i metana** te za **biougljen**: cijene i dnevne količine koje se može prodati (predefinirano 0 u Excelu, moguća promjena)
- **Parametrizacija procesa pretvorbe i pohrane** u P2G čvorištu: masena/energetska učinkovitost, jedinični investicijski trošak, životni vijek (postojeće predefinirane vrijednosti u Excelu, moguća promjena)



Izlazi iz Optimizacijskog alata (Excel sučelje)

- Veličina svih komponenata P2G čvorišta
 - Raspored rada za sve komponente dizajniranog P2G čvorišta za odabrani period (do maksimalno godine dana)
- Svi investicijski i operativni troškovi za dizajnirano čvorište, s procijenjenim RoI periodom
- Svi maseni/energetski tokovi između P2G čvorišta s REP/IP te mreža/vansjkih aktora, izraženi u fizikalnim veličinama i novčanim obujmima
- Detaljan i izveziv pregled rasporeda rada svih komponenata u P2G čvorištu



Optimalne P2G investicije (tipični rezultati)

→ **Proizvodnja biometana:**

- BM > AD > Metanizacijski reaktor i elektrolizator > Plinska mreža
- BC > Gasifikacija i pomak voda-plin > Metanizacijski reaktor (i elektrolizator) > Plinska mreža

→ **Proizvodnja električne energije:**

- Biomasa > AD > Bioplin > CHP > Električna mreža
- Plinska mreža > CHP > Električna mreža

→ **Proizvodnja vodika:**

- Demineralizacija/Kišnica > Pohrana vode > Elektroliza > Vodik

→ **Nulta investicija**



Demonstracija Atlasa i Optimizacijskog alata

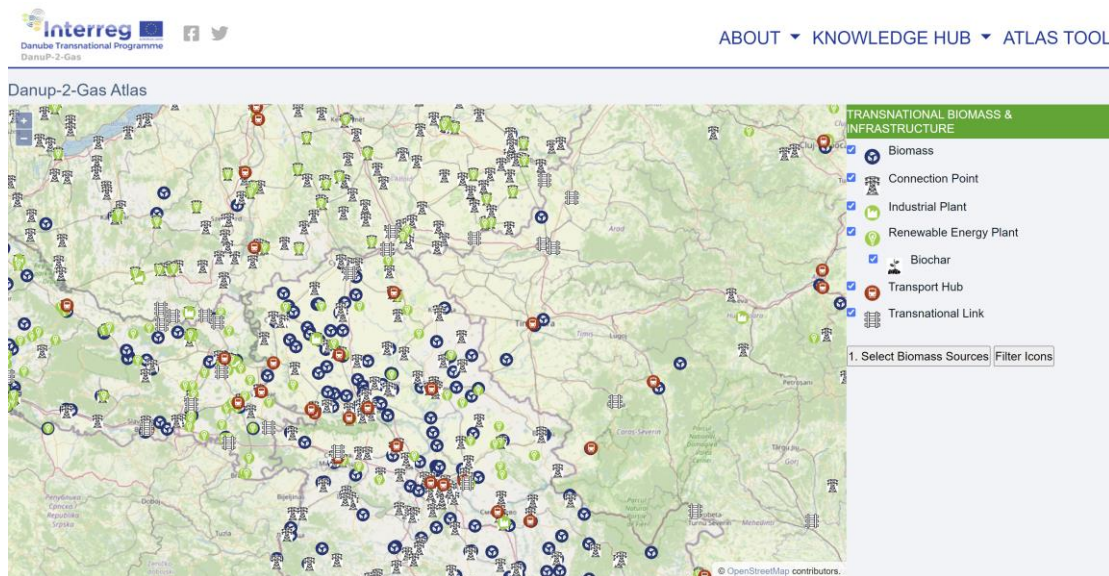

<https://danup2gas.eu/optimizationtool>

<https://www.danup2gas.eu/atlas>

Investment parameters		
Parameter	Value	Unit
Maximal investment payoff period	20	years
Administration and building period	5	years
Maximal investment	1.000.000.000	€
Use same subsidy for all parts of the P2G hub?	Yes	
Investment subsidy	0,0	%

Optimization parameters			
Parameter	Value	Unit	
Starting date of simulation	1.1.2022	Pick date	
Last date of simulation	31.12.2022	Pick date	
Sampling time for electrical part	24	h	
Amount of memory required (cca)	1,37	GB	

Additional sales parameters		
Parameter	Value	Unit
H ₂	Price for selling hydrogen	0,00 €/kg
	Limit of daily hydrogen sale	0,00 kg/day
O ₂	Price for selling oxygen	0,00 €/kg
	Limit of daily oxygen sale	0,00 kg/day
CH ₄	Price for selling methane	0,00 €/kg
	Limit of daily methane sale	0,00 kg/day
BC	Price for selling biochar	0,00 €/kg
	Limit of daily biochar sale	0,00 kg/day
Tax on CO ₂ emissions	0,00	€/kg

Monthly precipitation					
Month	Value	Unit	Month	Value	Unit
January	80	mm	July	50	mm
February	100	mm	August	50	mm
March	100	mm	September	200	mm
April	80	mm	October	100	mm
May	60	mm	November	100	mm
June	50	mm	December	100	mm

Start Optimization

Optimization output



Hvala na pažnji

Mario Vašak, mario.vasak@fer.hr

Marijo Šundrica, marijo.sundrica@fer.hr

Filip Rukavina, filip.rukavina@fer.hr

Antonio Karneluti, antonio.karneluti@fer.hr

Smart City Technologies



LARES



Danube Transnational Programme
DanuP-2-Gas



<https://www.interreg-danube.eu/danup-2-gas>

<https://www.lares.fer.hr>